

Technical data Corode magnetic drive pumps

MAG-25 PP/ PVDF

Materials available :PP or PVDF
 O-ring :EPDM or Viton
 Max. flow :23m³/h
 Max. head :19.3mtr.
 Max. temperature :PP 60°C; PVDF 90°C
 Max. viscosity :200 cSt
 Motor :1.5kW, 400V, 5.3/3.1Amp, 3Ph, 50Hz, IP55

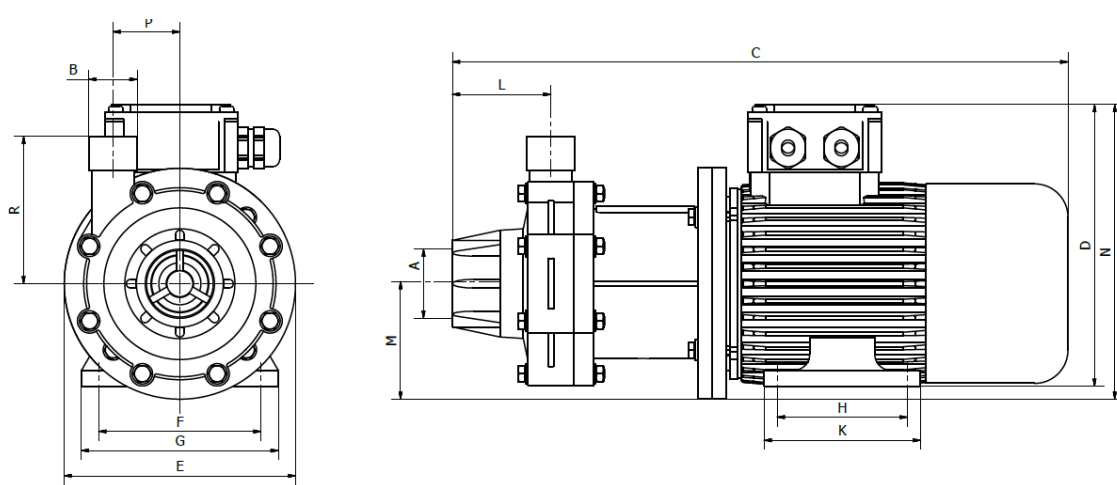

	A	B	C	D	E	F	G	H	K	L	M	N	P
MAG-25	2"out	1 1/2"out	536	225	200	125	160	100	140	80	100	240	66

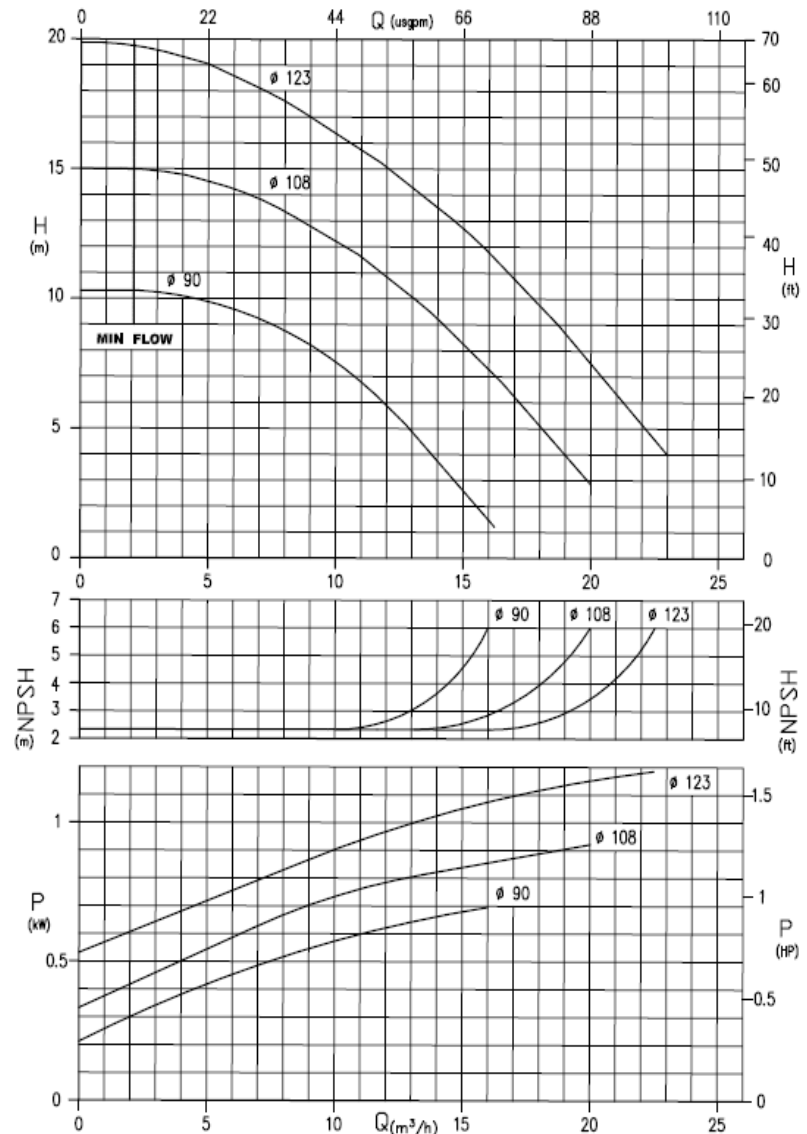

www.corode.eu

tel: +31 (0)161-244250

corode@corode.nl